



Single Phase 8.0Amp Glass passivated Bridge Rectifiers

Features

- The plastic package carries Underwriters Laboratory Flammability Classification 94V-0
- Idea for printed circuit board
- Glass passivated junction chip
- Low reverse leakage
- High forward surge current capability
- High temperature soldering guaranteed
260°C/10 seconds at terminals

Mechanical Data

- Case : Molded plastic body
- Terminals : Solder plated, solderable per MIL-STD-750,Method 2026
- Polarity : Polarity symbol marking on body
- Mounting Position : Any

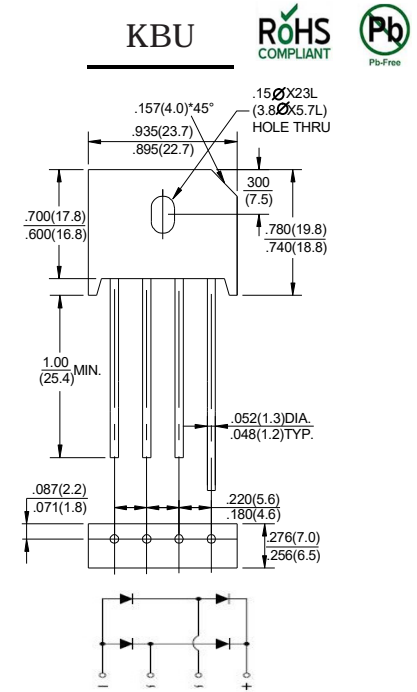

Dimensions in inches and (millimeters)

Maximum Ratings And Electrical Characteristics

Ratings at 25°C ambient temperature unless otherwise specified. Single phase half-wave 60Hz, resistive or inductive load, for capacitive load current derate by 20%.

Parameter	Symbols	KBU8005	KBU801	KBU802	KBU804	KBU806	KBU808	KBU810	Units
Maximum repetitive peak reverse voltage	V_{RRM}	50	100	200	400	600	800	1000	V
Maximum RMS voltage	V_{RMS}	35	70	140	280	420	560	700	V
Maximum DC blocking voltage	V_{DC}	50	100	200	400	600	800	1000	V
Maximum average forward rectified current with heatsink	$I_{(AV)}$	8.0							A
Peak forward surge current, 8.3ms single half sine-wave superimposed on rated load	I_{FSM}	175.0							A
Rating for fusing (t=8.3ms, Ta=25°C)	I^2t	127							A ² s
Maximum instantaneous forward voltage at 8.0A	V_F	1.10							V
Maximum DC reverse current T _A =25°C at rated DC blocking voltage T _A =100°C	I_R	5.0 200							uA
Typical junction capacitance (Note 1)	C_J	53.0							pF
Typical thermal resistance	R_{qJA}	35.0							°C/W
Operating junction and storage temperature range	T _J , T _{STG}	-55 to +150							°C

Note: 1. Measured at 1MHz and applied reverse voltage of 4.0V D.C.



Ratings And Characteristic Curves

FIG. 1- DERATING CURVE OUTPUT RECTIFIED CURRENT

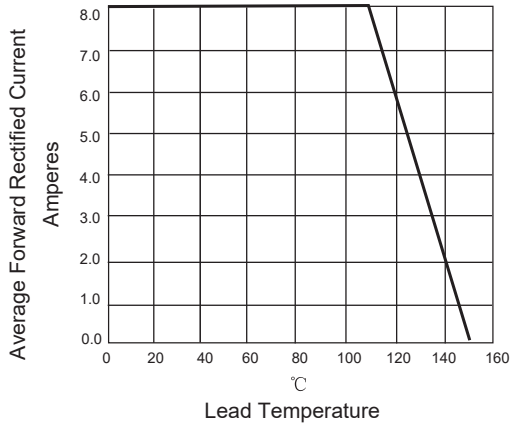

FIG. 2-MAXIMUM NON-REPETITIVE PEAK FORWARD SURGE CURRENT PER LEG

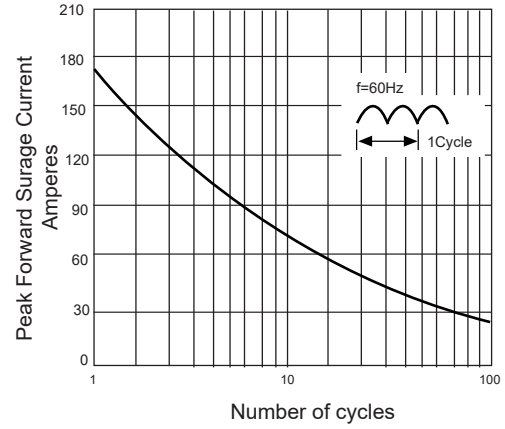

FIG. 3-TYPICAL FORWARD VOLTAGE CHARACTERISTICS

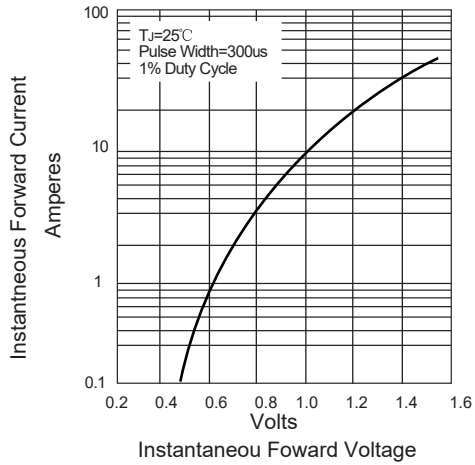
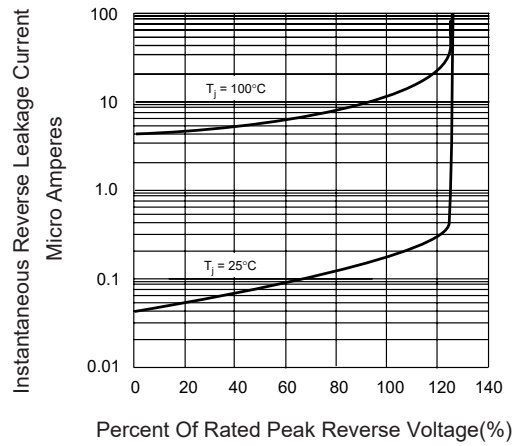
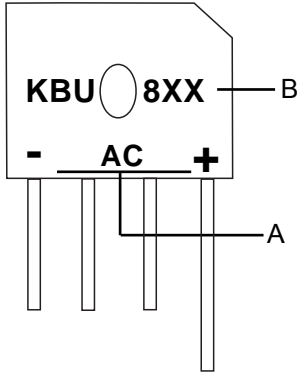

FIG. 4-TYPICAL REVERSE LEAKAGE CHARACTERISTICS





Marking



Symbol	Explanation
A	Polarity Symbol
B	Product Name,X : 005.01.....10

Suggested Soldering Temperature Profile

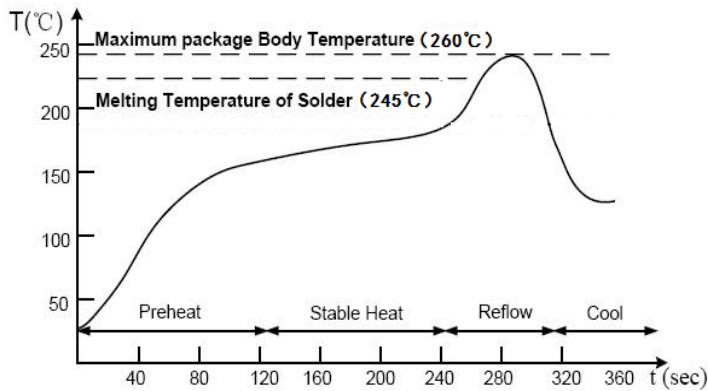

Note

- Recommended reflow methods: IR, vapor phase oven, hot air oven, wave solder.
- The device can be exposed to a maximum temperature of 260°C for 10 seconds.
- Devices can be cleaned using standard industry methods and solvents.
- If reflow temperatures exceed the recommended profile, devices may not meet the performance requirements.